



ECIT'2002

Iasi City, Romania, July 17-20, 2002
Iasi City, Romania, July 17-20, 2002

ROSYCS 2002

Program

Joint Conferences

Second European Conference on
**Intelligent Systems
and Technologies**

ECIT 2002
and
ROSYCS 2002

Iasi, July 17-20, 2002



Session on Internet-based Systems and E-Commerce
Main Hall of the Romanian Academy-Iasi Branch, 19 July, 9:00-10:30
Chairman: Prof. S. Zahan

Firewalls: an Effective Solution for Internet Security

V. Iordan

West University, Timisoara, Romania

Designing Agent-Based Systems Using UML and Extensions

M. Dinsoreanu, I. Salomie, K. Pusztai

Technical University, Cluj-Napoca, Romania

Service Provider Intelligent Decision System for a Free 3G Market

S. Zahan¹, J. Bigham², M. Cremene¹, I. Benta¹

Technical University, Cluj-Napoca, Romania¹,

Queen Mary College, University of London, UK²

Content Management System of a new generation

A. Colesnicov, L. Malahova

Institute for Applied Mathematics and Informatics, Chisinau (Kishnew), R. Moldova

Special Session on Simulation Techniques in Electronics

Auditorium P8, Technical University "Gh. Asachi", Iasi, July 17, 14:30-16:30

Chairman: Prof. A. Sarbu

Optimal Design of Three-Phase Rectifiers with Almost Sinusoidal Input Currents using Saber

A. Sarbu, D. Alexa, I. Cleju

Technical University "Gh. Asachi", Iasi, Romania

On Isolation Coreless PCB Transformers

T. Goras, L. Goras, A. Maiorescu, R. Ghinea

Technical University "Gh. Asachi", Iasi, Romania

VHDL Delay Modeling of Submicrometer CMOS Logic Inverters

D. Burdia

Technical University "Gh. Asachi", Iasi, Romania

Simulation Model for Mobile Radio Channels

C. Comsa, I. Alexandrescu, A. Maiorescu, I. Bogdan

Technical University "Gh. Asachi", Iasi, Romania

RF CMOS LNA's Noise Figure Improving Technique

C.M. Păvăluță, C. Neacșu, M. Derevlean, N. Cojan

Technical University "GH. Asachi" Iasi, Electronics and Telecommunication Faculty, , Romania

Simulation Model for Mobile Radio Channels

Ciprian Comşa, Iolanda Alecsandrescu, Andrei Maiorescu, Ion Bogdan

Technical University "Gh. Asachi" Iaşi, Department of Telecommunications

Abstract

Narrowband radio channels are usually assumed to be non-frequency selective. For such fading type a highly flexible analytical channel model is used that is based on the extended Suzuki process and takes into account short-term fading with superimposed long-term lognormal variations of the local mean. The distribution of the envelope of the stochastic process contains Rice, Rayleigh and one-sided Gaussian distribution as special cases. A simulation model is derived and, based on it, simulations with Matlab and Saber tools are run.

Keywords

Mobile radio channel simulation model, non-frequency selective fading, extended Suzuki process, mixed hardware description language MAST.

1. Introduction

A mobile communication system has to work in various propagation conditions, which depends on the building materials, the shape and the dimensions of buildings, on the streets distribution and length, on the vegetation and mostly on the permanent moving of peoples and vehicles. The radio channel is a propagation medium characterized by wave phenomena like reflection, diffraction, scattering and absorption.

The precise knowledge of the geometric dimensions and electromagnetic properties of the environment should allow a good description of all these phenomena and enable the derivation of an accurate channel model. Unfortunately this procedure requires a large mathematical effort and the continuous changing environment complicates the modeling. This is why some researchers tried to reduce the complex propagation process to its main features characterizing the fundamental statistical properties of the mobile radio channel.

In urban environments the probability of the mobile station's antenna being in the direct line-of-sight (LOS) of the base station's antenna is extremely low. So the propagation is realized mostly by reflection and diffraction. The mobile station receives a lot of waves on different propagation ways and with different amplitudes and phases. Summing all these waves, the resulted amplitude's value can be very different in the very close neighborhood. Variation of amplitude in this case is called short-term fading, caused by the local multi-path propagation and follows in urban environments, often closely, a Rayleigh distribution.

Usually the propagation losses are studied on a limited geographic zone, following the local mean of the received radio signal's power. The variations of the local mean from one zone to another describes the long-term fading, due especially to shadowing, because this kind of variations becomes important rather when the mobile is passing through the "shadow" of a big building or hill. Usually the local means are log-normally distributed.

From the mobile's point of view, there is no difference between short-term fading and long-term fading, because the received radio signal's variations are perceived temporarily, depending on the mobile's speed. Moreover, due to environment modifications, these variations of the signal appears even when the mobile is in a steady state.

A mobile radio channel has to allow the evaluation of the propagation losses and their variations, meaning the fading. The most important parameters of the fading are: the depth of the fading, which is the amplitude of propagation losses variations; the level-crossing rate (LCR), which is the average number of crossings per second at which the envelope crosses a specified signal level with a positive slope and the

average duration of fades (ADF), which is the expected value for the length of time intervals over which the signal envelope is below a specified level.

Another phenomenon involved in the mobile radio channel modeling is the Doppler effect. A mobile station receives a frequency deviated from the transmitted frequency according to the mobile's speed and direction. The deviation of frequency is called Doppler frequency and it reaches its maximum value when the mobile is moving on the base station's direction.

$$f_{\max} = \frac{v}{\lambda} \quad (1)$$

with v being the mobile speed and λ - the wavelength of the transmitted frequency.

An widely accepted statistical model for large classes of mobile radio channels is the Suzuki process, that represents the envelope of the received signal as a product between a Rayleigh distribution process and a lognormally distributed one. The Rayleigh process is regarded as the envelope of a complex-valued Gaussian noise process, with the inphase and quadrature components statistically independent. Such an assumption does not always meet the real-world conditions in multipath wave propagation and, therefore, modified Suzuki processes have been introduced, with components allowed to be cross-correlated. A statistical channel model based on a product process of Rice and lognormal process was proposed and extended in such a way that the two Gaussian processes describing the Rice process are allowed to be cross-correlated. This way the Suzuki model is extended and it becomes a product process of a lognormal process and a stochastic one with cross-correlated components. The complex stochastic process introduced in [4] has the inphase and quadrature components derived from a single colored Gaussian noise process. The distribution of the envelope of that complex process contains the Rice, Rayleigh and one-sided Gaussian distribution as special cases.

In this paper the extended Suzuki model is presented and, the simulation model is derived, and methods for obtaining the simulation parameters are envisaged.

Lately the software tools and hardware description languages (HDL) have a wide range of usage, including integrated circuits, application specific integrated circuits (ASIC), board and system design. Thus, models for these simulation tools have the advantage that they can be used for simulations in different phases of designing, from software to hardware.

In today's design environment, an essential element is mixed-signal simulation. This is not just due to the fact that most electronic systems today contain some combination of analog and digital circuitry, but also because the size, complexity and operating speeds of these circuits and systems have grown very much over the past decade. Three dominating options in mixed-signal modeling are Verilog-AMS, VHDL-AMS and MAST, developed by Analogy [1].

This is why the simulation model for mobile channels is developed according to MAST language's specifications and simulation results with Saber Designer (the simulation environment for MAST templates) are presented.

2. Extended Suzuki model

The extended Suzuki model for mobile radio channel proposed in [4] takes into account short-term fading with superimposed long-term lognormal variations of the local mean value of the received signal. Also it is assumed that the mobile channel is non-frequency-selective. The statistical channel model $\eta(t)$ is based on a product process of a lognormal process $\zeta(t)$ and stochastic process $\xi(t)$ with underlying cross-correlated components:

$$\eta(t) = \zeta(t) \cdot \xi(t) \quad (2)$$

The stochastic model for the modeling of the short-term fading variations uses a single zero mean Gaussian noise process to produce a complex Gaussian noise process:

$$\mu(t) = \mu_1(t) + j \cdot \mu_2(t) \quad (3)$$

with cross-correlated quadrature components $\mu_1(t)$ and $\mu_2(t)$:

$$\mu_i(t) = \frac{1}{\sqrt{2\pi} \cdot \sigma_{\mu_i}^2} \cdot e^{-\frac{t^2}{2\sigma_{\mu_i}^2}}, \quad i = \{1,2\} \quad (4)$$

The LOS component is taken into consideration and it is supposed to be independent of time for short time fading variations:

$$m_\rho = m_1 + j \cdot m_2 = \rho \cdot e^{j \cdot \theta_\rho} \quad (5)$$

where θ_ρ denotes the phase and ρ is the amplitude of the LOS component. The stochastic process $\xi(t)$ is obtained from the nonzero mean complex Gaussian noise process $\mu_\rho(t) = \mu(t) + m_\rho$

$$\xi(t) = |\mu_\rho(t)| = \sqrt{(\mu_1(t) + m_1)^2 + (\mu_2(t) + m_2)^2} \quad (6)$$

A widely accepted power spectral density (PSD) function for mobile fading channel is the Jakes PSD [3]:

$$S_{\mu_i}(f) = \begin{cases} \frac{\sigma_{\mu_i}^2}{\pi \cdot f_{\max} \cdot \sqrt{1 - \left(\frac{f}{f_{\max}}\right)^2}}, & |f| < f_{\max} \\ 0, & |f| \geq f_{\max} \end{cases}, \quad i = \{1,2\} \quad (7)$$

where f_{\max} represents the maximum Doppler frequency and $\sigma_{\mu_i}^2$ denotes the mean power:

$$\sigma_{\mu_i}^2 = \int_{-\infty}^{\infty} S_{\mu_i}(f) \cdot df = \sigma_0^2, \quad i = \{1,2\} \quad (8)$$

Applying the inverse Fourier transform to $S_{\mu_i}(f)$ function, results the autocorrelation function of the process $\mu_i(t)$

$$r_{\mu_i}(t) = \sigma_{\mu_i}^2 \cdot J_0(2\pi \cdot f_{\max} \cdot t), \quad i = \{1,2\} \quad (9)$$

where $J_0(\cdot)$ denotes the zeroth-order Bessel function of the first kind.

The Jakes PSD has a symmetrical shape because the incoming directions of the received multipath waves are assumed to be uniformly distributed in the interval $(0, 2\pi]$. If some of the multipath waves are blocked by obstacles or absorbed by the environment, the resulting Doppler PSD of the complex Gaussian noise process $\mu(t)$ becomes asymmetrical and restricted by the correction of f_{\max} with a factor k_0 , where $0 < k_0 \leq 1$. So, according to [4], $S_{\mu_i}(f)$ becomes:

$$New S_{\mu_i}(f) = \text{rect}\left[\frac{f}{k_0 \cdot f_{\max}}\right] \cdot 2 \cdot [1 + \text{sgn}(f) \cdot \sin(\alpha)] \cdot S_{\mu_i}(f), \quad i = \{1,2\} \quad (10)$$

where $\alpha \in (0, \pi)$ is introduced as a correlation factor.

Also according to [4], depending on the factor α and the LOS component, the process $\xi(t)$ becomes Rice distributed for $\alpha = 90^\circ$ (11), Rayleigh for $\alpha = 90^\circ$ and $\rho = 0$ (12) or has a one-sided Gaussian density for $\rho = 0$ and $\alpha \rightarrow 0$ (13).

$$p_\xi(t) \Big|_{\alpha=90^\circ} = \frac{t}{\Psi_0} \cdot e^{-\frac{t^2 + \rho^2}{2 \cdot \Psi_0}} \cdot J_0\left(\frac{t \cdot \rho}{\Psi_0}\right) \quad (11)$$

$$p_\xi(t) \Big|_{\substack{\alpha=90^\circ \\ \rho=0}} = \frac{t}{\Psi_0} \cdot e^{-\frac{t^2}{2 \cdot \Psi_0}}, \quad t \geq 0 \quad (12)$$

$$p_{\xi}(t) \Big|_{\substack{\alpha \rightarrow 0 \\ \rho = 0}} = \frac{t}{\sqrt{\pi \cdot \Psi_0}} \cdot e^{-\frac{t^2}{4 \cdot \Psi_0}}, \quad t \geq 0 \quad (13)$$

where $\Psi_0 = \frac{2}{\pi} \cdot \sigma_0^2 \cdot \arcsin(k_0)$.

This model is valid only for short distances covered by the vehicle. In such a case, the local mean of the received signal strength, like the time-average value of $\xi(t)$ over a few tens of wavelengths, is approximately a constant quantity. For longer distances, the local mean itself is a random variable, and a more precise model can be obtained by multiplying the stochastic process $\xi(t)$ with a lognormal process. Long-term variations of the signal received are caused by shadowing effects, and it has been shown by many authors [2], [5] that the local-mean variations are lognormally distributed.

The lognormal process $\zeta(t)$ (15) can be derived from another real Gaussian noise process $\mu_3(t)$ with zero mean and unit variance

$$\zeta(t) = e^{m+s \cdot \mu_3(t)} \quad (14)$$

where m and s are two parameters determining the statistical properties of the local mean of the received signal.

$$p_{\zeta}(t) = \begin{cases} \frac{1}{\sqrt{2\pi} \cdot s \cdot t} \cdot e^{-\frac{(\ln t - m)^2}{2 \cdot s^2}}, & t > 0 \\ 0, & t \leq 0 \end{cases} \quad (15)$$

The real Gaussian process $\mu_3(t)$ and the complex Gaussian process $\mu(t)$ defined by (3) are not cross-correlated. According to [4], the PSD function of $\mu_3(t)$, given by the Gaussian PSD is

$$S_{\mu_3}(f) = \frac{1}{\sqrt{2\pi} \cdot \sigma_c} \cdot e^{-\frac{f^2}{2 \cdot \sigma_c^2}} \quad (16)$$

where σ_c is related to the 3-dB cutoff frequency,

$$f_c = \sigma_c \cdot \sqrt{2 \cdot \ln 2} \quad (17)$$

Generally $f_c \ll f_{\max}$, so it may be useful to introduce the coefficient

$$k_c = \frac{f_{\max}}{f_c} \gg 1 \quad (18)$$

The analytical model for lognormal process is depicted in Fig.1, where the process $\mu_3(t)$ is obtained by passing white Gaussian noise $n_1(t)$ with zero mean and unit variance through an ideal low-pass filter with transfer function $H_1(f) = \sqrt{S_{\mu_3}(f)}$.

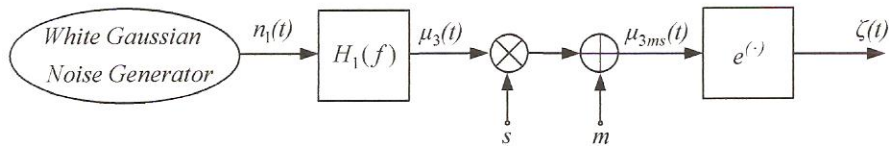

Figure 1 – Analytical model for lognormal process

Applying the Fourier transform to the function $S_{\mu_3}(f)$, the autocorrelation function of the Gaussian process $\mu_3(t)$ is

$$r_{\mu_3}(t) = e^{-2 \cdot (\pi \cdot \sigma_c \cdot t)^2} \quad (19)$$

3. Simulation model and results

Until now it has been shown that an extended Suzuki process is based on the generation of three Gaussian noise processes $\mu_i(t)$, $i = \{1, 2, 3\}$. The first two processes are obtained from a single colored Gaussian noise process $\nu_0(t)$; therefore $\mu_1(t)$ and $\mu_2(t)$ are cross-correlated. Using $\mu_1(t)$ and $\mu_2(t)$, a complex Gaussian noise process $\mu(t)$ is obtained (3). The processes $\mu(t)$ and $\mu_3(t)$ are not correlated.

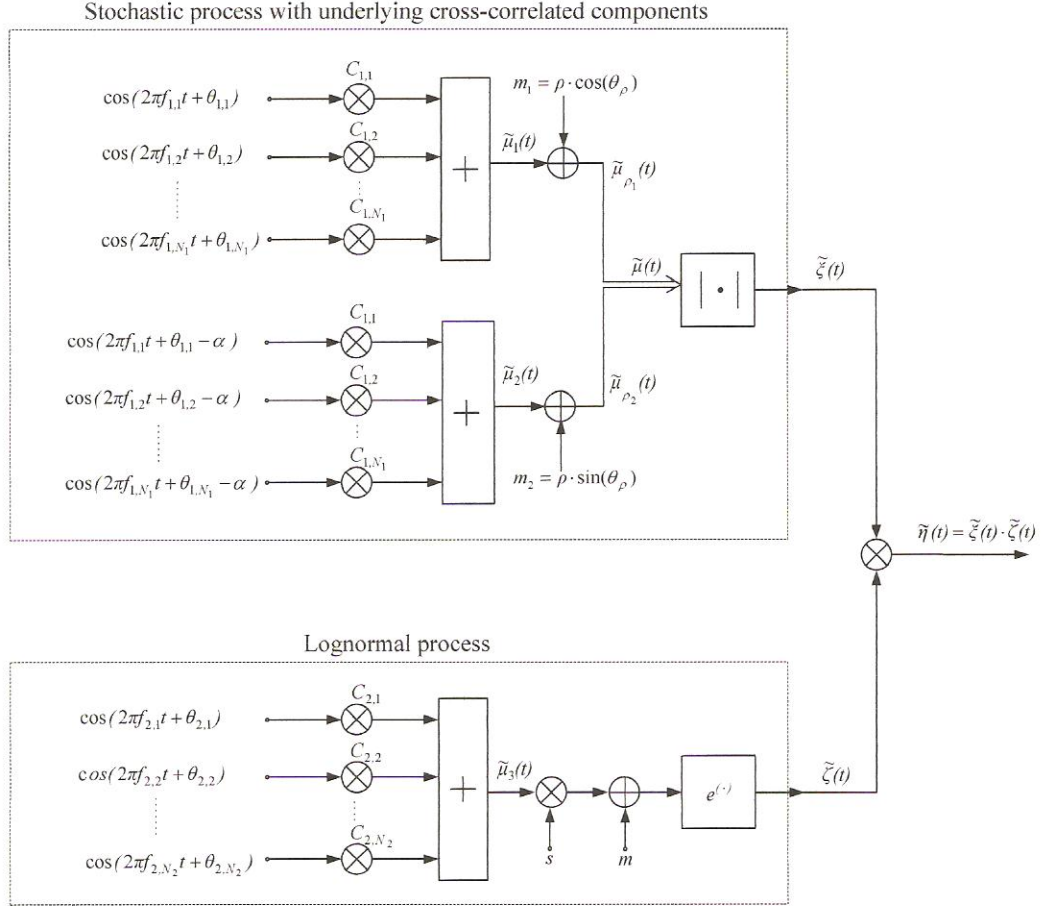

Figure 2 – Structure of the deterministic simulation system

For simulation are used the processes $\tilde{\mu}_i(t)$, $i = \{1, 2, 3\}$ which approximates the Gaussian noise processes $\mu_i(t)$, $i = \{1, 2, 3\}$. The stochastic processes $\mu_i(t)$, $i = \{1, 2, 3\}$ are replaced by the following sums of sinusoids:

$$\tilde{\mu}_1(t) = \sum_{n=1}^{N_1} c_{1,n} \cdot \cos(2\pi \cdot f_{1,n} \cdot t + \theta_{1,n}) \quad (20a)$$

$$\tilde{\mu}_2(t) = \sum_{n=1}^{N_1} c_{1,n} \cdot \cos(2\pi \cdot f_{1,n} \cdot t + \theta_{1,n} - \alpha) \quad (20b)$$

$$\tilde{\mu}_3(t) = \sum_{n=1}^{N_1} c_{2,n} \cdot \cos(2\pi \cdot f_{2,n} \cdot t + \theta_{2,n}) \quad (20c)$$

where $c_{i,n}$, $f_{i,n}$ and $\theta_{i,n}$ are called Doppler coefficients, discrete Doppler frequencies, and Doppler phases, respectively; N_1 and N_2 represents the number of sinusoids used to approximate the stochastic process. Because the processes $\tilde{\mu}_1(t)$ and $\tilde{\mu}_2(t)$ are cross-correlated, the only difference between them is the correlation factor α , where $\alpha \in (0, \pi)$.

Hereby, the general simulation model is a deterministic model used for the approximation and simulation of the stochastic processes $\xi(t)$, $\zeta(t)$ and $\eta(t)$ and it is illustrated in Fig. 2.

The simulation coefficients which have to be computed are $c_{i,n}$, $f_{i,n}$ and $\theta_{i,n}$. The values of $c_{i,n}$ and $f_{i,n}$ are calculated at the beginning and kept constants during the simulation, while the Doppler phases $\theta_{i,n}$ are modified each simulation step given by sampling. Note that the values of the system's signals are computed at discrete moments of time

$$t = k \cdot T_a, \quad k = 1 \dots N_s \quad (21)$$

where T_a is the sampling interval and N_s represents the number of samples.

Depending on the simulation parameters $c_{i,n}$ and $f_{i,n}$, the analytical expressions for the autocorrelation function $r_{\tilde{\mu}_j}(t)$ and power spectral density are given by (22).

$$r_{\tilde{\mu}_j}(t) = \sum_{n=1}^{N_i} \frac{c_{i,n}^2}{2} \cdot \cos(2\pi \cdot f_{i,n} \cdot t), \quad (j,i) = \{(1,1), (2,1), (3,2)\} \quad (22a)$$

$$S_{\tilde{\mu}_j}(f) = \sum_{n=1}^{N_i} \frac{c_{i,n}^2}{4} \cdot [\delta(f - f_{i,n}) + \delta(f + f_{i,n})], \quad (j,i) = \{(1,1), (2,1), (3,2)\} \quad (22b)$$

Moreover, regarding the complex process

$$\tilde{\mu}(t) = \tilde{\mu}_1(t) + j \cdot \tilde{\mu}_2(t) = \sum_{n=1}^{N_1} c_{1,n} \cdot e^{j(2\pi \cdot f_{1,n} t + \theta_{1,n})} \quad (23)$$

the cross-correlation function is given by:

$$r_{\tilde{\mu}_1, \tilde{\mu}_2}(t) = \sum_{n=1}^{N_i} \frac{c_{1,n}^2}{2} \cdot \sin(2\pi \cdot f_{1,n} \cdot t) \quad (24)$$

having $r_{\tilde{\mu}_1, \tilde{\mu}_2}(0) = 0$ and $r_{\tilde{\mu}_1, \tilde{\mu}_2}(-t) = -r_{\tilde{\mu}_1, \tilde{\mu}_2}(t)$.

The simulation parameters may be determinate using conditions:

$$r_{\tilde{\mu}_j}(t) = r_{\mu_j}(t), \quad j = \{1, 2, 3\} \quad (25a)$$

$$S_{\tilde{\mu}_j}(f) = S_{\mu_j}(f), \quad j = \{1, 2, 3\} \quad (25b)$$

$$r_{\tilde{\mu}_1, \tilde{\mu}_2}(t) = r_{\mu_1, \mu_2}(t) \quad (25c)$$

In this paper the cross-correlation function of the real Gaussian noise processes $\mu_1(t)$ and $\mu_2(t)$ is neglected, so the Doppler coefficients $c_{i,n}$, $n = 1 \dots N_i$, $i = \{1, 2\}$, and the Doppler frequencies $f_{i,n}$, $n = 1 \dots N_i$, $i = \{1, 2\}$ are subtracted from the conditions that the autocorrelation function and the power spectral density of processes $\tilde{\mu}_j(t)$, $j = \{1, 2, 3\}$ must be as much as possible the same with the autocorrelation function and power spectral density, respectively, of processes $\mu_j(t)$, $j = \{1, 2, 3\}$, as it is shown in (25a) and (25b). The values so founded for $c_{i,n}$ and $f_{i,n}$ are kept constant for the rest of the simulation. From (22) it may be observed that $r_{\tilde{\mu}_j}(t)$ and $S_{\tilde{\mu}_j}(f)$ are not depending on the Doppler phases. The statistic of the radio mobile channel depends on Doppler coefficients and Doppler frequencies, but for the same statistic properties, variations of $\mu_j(t)$, $j = \{1, 2, 3\}$ are obtained using different sets of values for $\theta_{i,n}$, $n = 1 \dots N_i$, $i = \{1, 2\}$. For N_s sample points, at each sampling moment there is determined one set of Doppler phases $\theta_{i,n}$, $n = 1 \dots N_i$, $i = \{1, 2\}$, which is obtained using a

generator of random sequences of numbers. Also, one set of Doppler phases $(\theta_{i,1}, \theta_{i,2}, \dots, \theta_{i,N_i})$ can be viewed as a permutation of the elements of the vector $\left(2\pi \cdot \frac{1}{N_i+1}, 2\pi \cdot \frac{2}{N_i+1}, \dots, 2\pi \cdot \frac{N_i}{N_i+1}\right)$, for $i = \{1, 2\}$. Consequently, the Doppler phases are uniform distributed in the interval $(0, 2\pi]$.

As it is presented in [3] there are four different methods for the determination of the Doppler coefficients and the corresponding discrete Doppler frequencies: method of equal distances, method of equal areas, Monte Carlo method and mean-square-error method. All the methods are quite different, but nevertheless they have in common that the resulting power spectral density function $S_{\tilde{\mu}_j}(f)$ is always an approximated version of the desired power density function $S_{\mu_j}(f)$, for $j = \{1, 2, 3\}$.

Applying the method of equal areas, [3], for the restricted Jakes PSD, the discrete Doppler frequencies $f_{1,n}$ are given by

$$f_{1,n} = f_{\max} \cdot \sin \left[\frac{\pi}{2 \cdot N_1'} \cdot \left(n - \frac{1}{2} \right) \right], \quad n = 1 \dots N_1 \quad (26)$$

where $N_1' = \left[\frac{N_1}{\frac{2}{\pi} \cdot \arcsin k_0} \right]$, and for the Gaussian PSD, the discrete Doppler frequencies $f_{2,n}$ are obtained by finding the zeros of

$$\frac{2n-1}{2N_2} - \operatorname{erf} \left(\frac{f_{2,n}}{f_{\max}} \cdot k_c \cdot \sqrt{\ln 2} \right) = 0, \quad n = 1 \dots N_2 \quad (27)$$

The corresponding Doppler coefficients $c_{i,n}$ are given by

$$c_{i,n} = \begin{cases} \sigma_0 \cdot \sqrt{\frac{2}{N_1'}}, & i=1 \quad (\text{Jakes PSD}) \\ \sqrt{\frac{2}{N_2}}, & i=2 \quad (\text{Gaussian PSD}) \end{cases} \quad (28)$$

For the simulation model presented for mobile radio channel, we have used for simulation $N_1 = 25$ and $N_2 = 15$ sinusoids for the generation of the Gaussian noise processes $\mu_1(t)$ and $\mu_2(t)$. Note that because of the Doppler spectrum's restrictions to $[-k_0 \cdot f_{\max}, k_0 \cdot f_{\max}]$, we used in (26) N_1' instead of N_1 . Also, the number of samples was considered $N_s = 10^8$ and the sampling period $T_a = 3 \cdot 10^{-8} s$. For simulations we supposed the maximum Doppler frequency $f_{\max} = 91 \text{ Hz}$ corresponding to a vehicle's speed of 110 km/h .

Table 1 – Simulation data

Shadowing	σ_0	k_0	α	ρ	θ_ρ	s	m	k_c
Light	0.7697	0.4045	164°	1.567	127°	0.0052	-0.3861	1.735
Heavy	0.2774	0.506	30°	0.269	45°	0.0905	0.0439	119.9

The rest of the data, shown in Table 1, were adopted from [4], considering the case of a measurement environment with heavy shadowing versus light shadowing. We also considered the values for simulation the values that determinate the stochastic process $\xi(t)$ to be Rice (11), Rayleigh (12) or one-sided Gaussian (13) distributed.

Figure no. 3 presents the time evolution of a signal generated by the simulation program and, at least apparently, it is similar to the one observed by measurements. In order to validate the simulation program several run were made in order to generate signals with predetermined statistical properties.

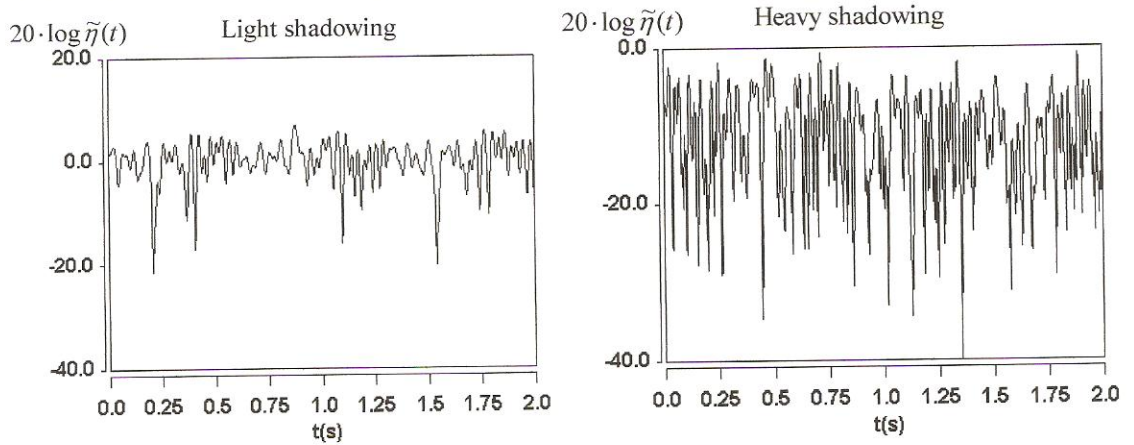

Figure 3 – Simulation of envelope $\tilde{\eta}(t)$

So, in figure no. 4b the probability density function for a signal with normal distributed envelope generated by the simulation program is presented against the analytical one and good agreements could be seen; figure no. 4a presents its time evolution.

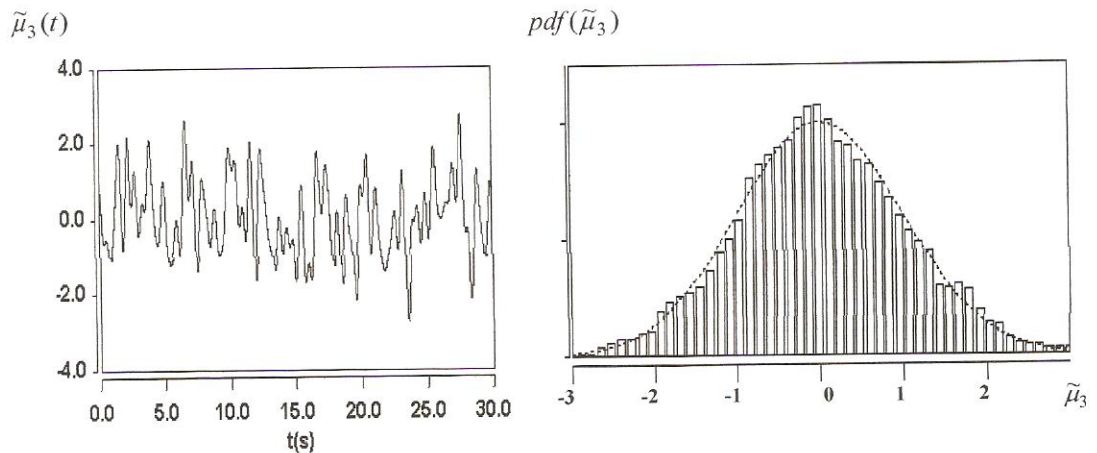

Figure 4 – Simulation of Gaussian noise process $\tilde{\mu}_3(t)$:

(a) envelope (b) histogram of simulation signal versus analytical probability density function

Good results were obtained for the Rayleigh distributed signal, too. As figure no. 5 reveals the difference between the generated signal distribution obtained as histogram and analytical probability density function (pdf) is hardly observable. In figure no. 6 it is shown the signal distribution of the log-normal process $\tilde{\xi}(t)$ also respects the analytical function.

The signal distribution for the process $\tilde{\eta}(t)$, which entirely models the radio mobile channel, was depicted in figure no. 7, for the two cases: light shadowing and heavy shadowing, respectively. One can notice that the signal distribution is like log-normal process for light shadowing and Rayleigh process for heavy shadowing, observations which are in concordance with the theoretical considerations for modeling the long-term fading and the short-term fading, respectively.

Finally, it deserves to point out the easiness of simulating the proposed model with the Saber design environment, especially due, in this case, to various statistical analysis implemented, including Monte Carlo, histogram etc. and measurements tools, including mean and standard deviation computing. For

instance, for the process $\tilde{\eta}(t)$, which has the distribution signal depicted in figure no. 7, the mean and the standard deviation are: $mean = 1.0693$ and $std_dev = 0.36904$ for light shadowing and $mean = 0.31696$ and $std_dev = 0.19371$ for heavy shadowing.

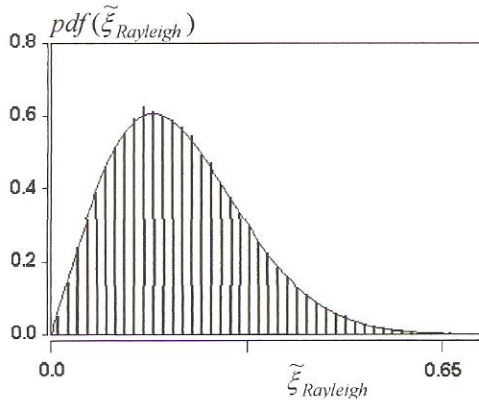

Figure 5 – Histogram versus analytical pdf for $\tilde{\xi}(t)$ Rayleigh distributed ($\alpha = 90^\circ$ and $\rho \rightarrow 0$)

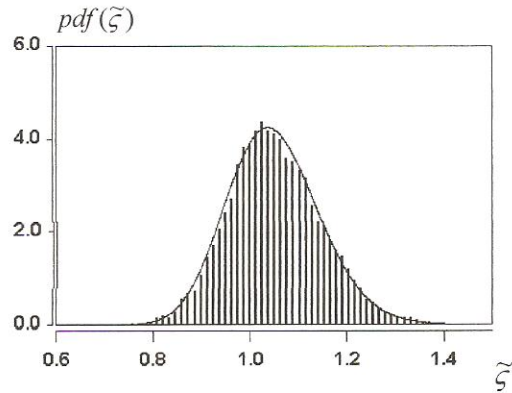

Figure 6 – Histogram versus analytical pdf for the log-normal process $\tilde{\zeta}(t)$

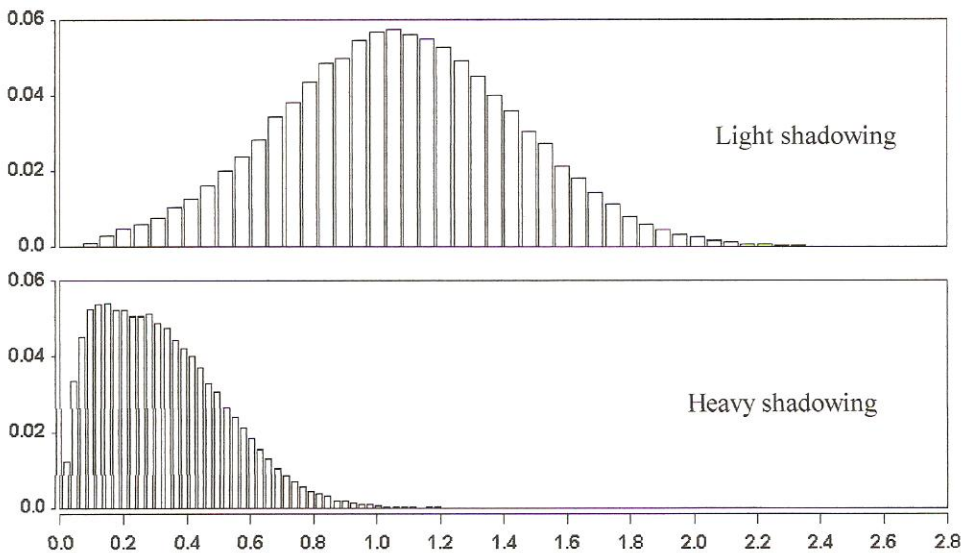

Figure 7 – Histogram of $\tilde{\eta}$, revealing the signal distribution

4. Conclusions

Theoretical considerations were made for modeling the radio mobile channel through an extended Suzuki process and simulation results are reported. The extended Suzuki process takes into account short-term fading with superimposed long-term log-normal variations of the local mean. The distribution of the envelope of the stochastic process contains Rice, Rayleigh and one-sided Gaussian distribution as special cases. The simulation model derived concludes a deterministic approximation of the stochastic processes involved by the analytical model. Acceptable error was obtained for most of the particular cases studied, but an optimization process should be performed in order to improve the simulation program yieldings.

The model was used for simulations with MAST, the advantages of using Saber design environment denoting from various statistical analyses enabled and mostly from the fact that MAST is a hardware description language and such a model can be used for simulations deeper to hardware systems.

References

- [1] R. S. Cooper: The designer's guide to analog & mixed-signal modeling illustrated with VHDL-AMS and MAST, Avant! Corp., 2001.
- [2] Y. Okumora, E. Ohmori, T. Kawano and K. Fukuda: Field strength and its variability in VHF and UHF land mobile radio services, Rev. Electr. Commun. Lab., vol. 16, Sept./Oct. 1968, pp.825-873.
- [3] M. Pätzold, U. Killat and F. Laue: A deterministic digital simulation model for Suzuki processes with application to a shadowed Rayleigh land mobile radio channel, IEEE Transactions on Vehicular Technology, vol. 45, no. 2, 1996, pp.318-331.
- [4] M. Pätzold, U. Killat, Y. Li and F. Laue: Modeling, analysis and simulation of nonfrequency-selective mobile radio channels with asymmetrical Doppler power spectral density shapes, IEEE Transactions on Vehicular Technology, vol. 46, no. 2, May 1997, pp.494-507.
- [5] D. O. Reudink: Comparison of radio transmission at x-band frequencies in suburban and urban areas, IEEE Transactions Antennas Propagation, vol. AP-20, July 1972, pp.470-473.